

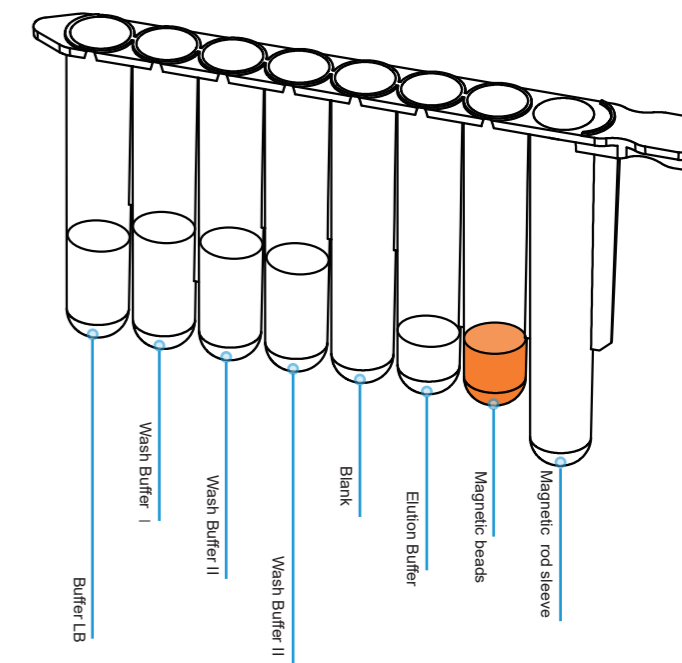

[Product size]

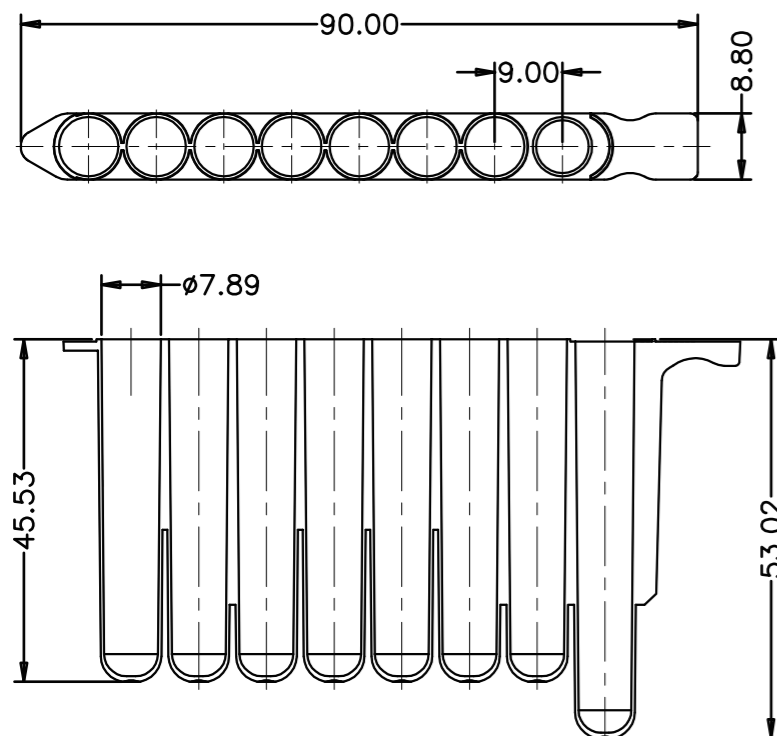

## Operating Instruction

# Nucleic Acid (DNA/RNA) Extraction Kit

 Notice: Please read the instruction of this product carefully and follow the operation instructions. Appropriate protective glasses, clothes and gloves are required during operation.

**Name of the filing entity/manufacturing company:** Wuxi Techstar Technology Co., Ltd.

**Address:** No.2 Workshop, No.117 Meiyu Road, Meicun Street, Xinwu District, Wuxi City, Jiangsu Province, China

**Contact information:** +86-510-6851 8058

**Website:** <http://www.tech-star.cn/>

**E-mail:** techstar8@163.com

**Production address:** No.2 Workshop, No.117 Meiyu Road, Meicun Street, Xinwu District, Wuxi City, Jiangsu Province, China

**Production filing certificate number:**

[Medical device filing certificate number/product technology requirement number]

**[Instruction verified and modified on]** 2020.05.08

**Version No.:** V1.0

**Copyright Statement:** All rights reserved by Wuxi Techstar Technology Co., Ltd.

**[Common name]** Nucleic Acid (DNA/RNA) Extraction Kit

**[Commercial name]** Magnetic Bead-Based Nucleic Acid (DNA/RNA) Extraction Kit

**[Product number]** SC902-50

**[Packing specification]** 50 Reactions

**[Intended use]** Extraction, enrichment and purification of nucleic acid

**[Transportation condition]** Room temperature

**[Preservation condition]** Room temperature or 2-8°C for long-term storage

**[Period of validity]** 12 months

**[Applicable instrument]** TECHSTAR YC701 Nucleic Acid Automatic Extraction System

### [Product introduction]

Magnetic Bead-Based Nucleic Acid (DNA/RNA) Extraction Kit is intended for the genomic DNA/RNA extraction of pathogenic microorganisms from serum, plasma, cultured cells, saliva, alveolar lavage fluid, nasopharyngeal aspirates and swabs samples with TECHSTAR YC701 Nucleic Acid Automatic Extraction System. The reagent kit is provided with the magnetic beads and buffer solution system featuring unique separation functions, with the special chemical group on the magnetic beads surface exerting extremely strong enrichment forces to DNA/RNA under given conditions for reversible release of DNA/RNA when conditions change, so as to separate and purify DNA/RNA as soon as possible and minimize impurities such as the protein. The DNA/RNA extracted with this kit is applicable to various downstream molecular biology experiments, such as qPCR, sequencing and genetic typing.

### [Product components]

Product name	Quantity and Specification
Preloaded reagent strip	50 strips
Proteinase K	1mL

 Important Notes! For preservation, please place all reagent strips and reagents uprightly at room temperature (15 °C-25 °C).

### [Reagent Preloading Location]

Well	Reagent	Volume
1	Buffer LB	500μL
2	Wash Buffer I	600μL
3	Wash Buffer II	600μL
4	Wash Buffer II	600μL
5	Blank	/
6	Elution Buffer	100μL
7	Magnetic beads	200μL
8	Magnetic rod sleeve	/

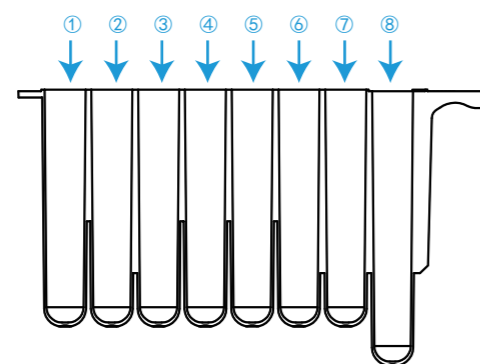

### [Operation procedures]

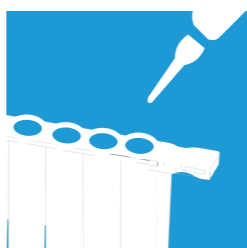

#### 1. Sample pretreatment

- 1)Serum or plasma: it should be a light yellow clear liquid without solid impurities, and no additional processing is required.
- 2)Cultured cells: with the supernatant discarded after centrifugation, it is used for extraction after being resuspended in normal saline or phosphate buffer.
- 3)Saliva, alveolar lavage fluid and nasopharyngeal aspirates: collected in accordance with related operation specifications. Thick samples must be extracted after liquidation.
- 4)Swabs: Including oropharyngeal swabs, nasopharyngeal swabs, genital swabs, etc. Put the swab into 0.5-1mL normal saline or phosphate buffer solution, stir for 2 minutes, Squeeze out the liquid and discard the swab, and the liquid is to be used for extraction. The solution can be directly used for extraction if the swab is placed in preserving solution.

#### 2. Reagent strip preparation

- 1)Before removing the sealing film, gently swing the reagent strip downward to concentrate the liquid or magnetic beads attached to the sealing film to the bottom of the strip.
- 2)Place the reagent strip on the strip holder, carefully tear off the sealing film to avoid the vibration of the reagent strip, prevent liquid from splashing.

 Important Notes! If the sealing film is layered during unsealing, it is recommended to tear it off from the opposite direction.

#### 3. Sample addition

- 1)Add 200μL pretreated sample to the first well of the reagent strip( samples of less than 200μL are recommended to make up to 200 μL with normal saline).
- 2)Add 20μL Proteinase K to the first well.

 Notice:① The 200 μL sample should be free of obvious solid impurities. If any, the supernatant should be taken by centrifugation for extraction.

②Liquid addition sequence must not be changed. The sample is added earlier than proteinase K solution.

#### 4. Instrument operation

1)Turn on the TECHSTAR YC701 nucleic acid automatic extraction system, place the reagent strip filled with sample and Proteinase K into the corresponding position, select a program to start extraction. Program "Universal" fits most samples and is recommended. (For detailed operating procedures, please refer to the User's Manual for TECHSTAR YC701 Nucleic Acid Automatic Extraction System).

2)After the instrument operation is completed, take out the reagent strip, the isolated and purified nucleic acid solution is contained in the sixth well of the reagent strip, which can be used directly for further test or be transferred into a new centrifuge tube for storage at -20°C for future use. It is recommended to store below -70 °C for long-term preservation.

### [Notes]

- 1.As a disposable product, this product cannot be reused.
- 2.Preservation of the reagent strip in low-temperature places such as the refrigerator may lead to relatively high solution viscosity or sediments. For such sediments found before operation, please heat the reagent strip at 37 °C and mix it gently to dissolve the sediments. Bubbles must be prevented during mixing.
- 3.Repeated freezing and thawing of the reagent strip are forbidden, otherwise the magnetic bead may be damaged.
- 4.For ruptured or layered sealing film when tearing the sealing film of the reagent strip, it is recommended to tear it off from the opposite direction.
- 5.Please operate carefully, as the solution contains a guanidine salt protein denaturant, which is corrosive. If it accidentally splashes on the skin, please rinse with plenty of water.
- 6.The reagent strip must be used within 30 minutes after unsealing, as long-term placement may affect the extraction effect.
- 7.To prevent reduced activity of proteinase K, sample should be added before proteinase K.
- 8.Fresh sample extraction is recommended. Repeated freezing and thawing of samples may lead to significantly decreased quantity of the nucleic acid.
- 9.As RNA is easily degraded, please use Rnase-free consumables. The nucleic acid must be used shortly after extraction and purification. If not, please store at minus 20 °C. Long-term storage is recommended below minus 70 °C.

### [Requirement for use]

- 1.The collection, transportation and storage of samples should comply with relevant specifications.
- 2.All samples, considered as a potential biological hazard, must be prevented from contact with skin or mucous membranes. Sample processing and operation should comply with relevant laws and regulations.
- 3.Discarded consumables and tips generated during the experiment are treated as medical waste.
- 4.Kits with damaged packaging or liquid leakage must not be used.

### [Symbol description]



Automatically invalid after one-time use



Do not use the product, if the package has been damaged or opened



Important warnings requiring users to refer to the instruction



Refer to the instructions for details

### [Quality assurance]

- 1.For quality problems resulted from manufacturing within the warranty period under the conditions of preservation, transportation and use specified in the instruction, users may contact the company or its designated agent.
2. Material cost, logistic expenses and travel expenses due to product damages resulted from operations in violation of the instruction within the warranty period are borne by the user.
- 3.Indicators and functions described herein may be changed or modified without prior notice.